

# Quick-Connect Poster

YHT-860

Home Theater in a Box

home theater



Yamaha created this package to greatly enhance your audio and home theater enjoyment. This Quick-Connect Poster will help you get started. Follow the steps to connect the speakers first. Then connect your DVD Player and other components. Refer to your Owner's Manuals as well as those that came with your other components for complete instructions and precautions. *Be sure that all components are not plugged in while making connections.* You will need the following which are not included in the package: Phillips screwdriver, wire cutter/stripper, optional for wall mounting: brackets, toggle bolts, molly anchor screws or sheet metal screws.



**Inspect Contents** After unpacking, inspect the contents to confirm you have the above items: 1 two surround speakers with tall support stands, 2 two front speakers with short support stands, 3 one center speaker, 4 subwoofer, 5 HTR-5850 A/V Receiver, 6 speaker wire, 7 subwoofer RCA cable, 8 four caps, 9 four adaptors 10 four stand brackets, 11 two table top bases for tall support stands, 12 two speaker stand bases for short support stands, 13 sixteen non-skid pads, 14 four adapter mounting screws, 15 eighteen base mounting screws, 16 twelve stand bracket mounting screws, 17 sixteen cap mounting screws, 18 OMNI mounting screws. Also included, but not shown, are remote control, AM and FM antennas and related Owner's Manuals.

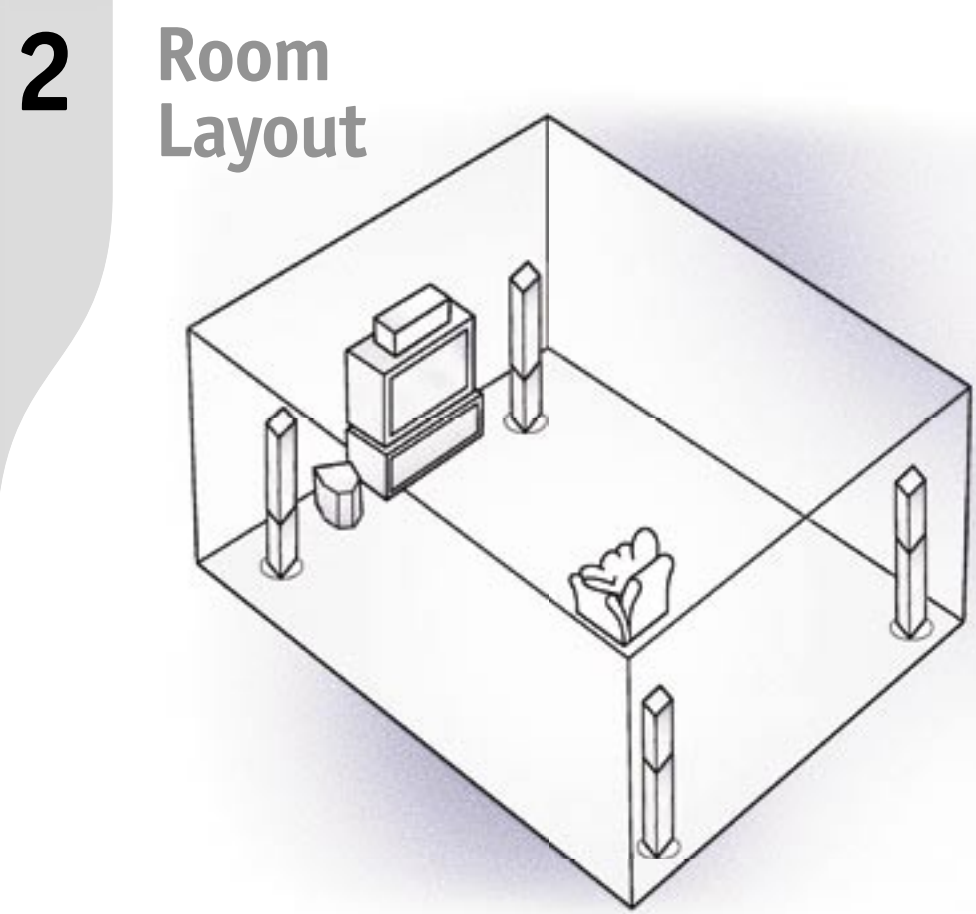

**Speaker Placement** After connection of the speakers place them so they appear in the approximate positions as shown in the diagram above.



**Connect Center Speaker Wire** as shown. The positive (+) side of the wire with the white stripe attaches to the red terminal. The negative (-) side attaches to the black terminal. Place all speakers in desired location as shown in Step 2, Room Layout.

**Mounting the Center Speaker (optional)** Place the center speaker on top of the TV or inside the TV rack so that it is stable. When placing the speaker on top of the TV, put the provided Velcro™ strips on the bottom of the speaker and the top of the TV to prevent the speaker from falling.

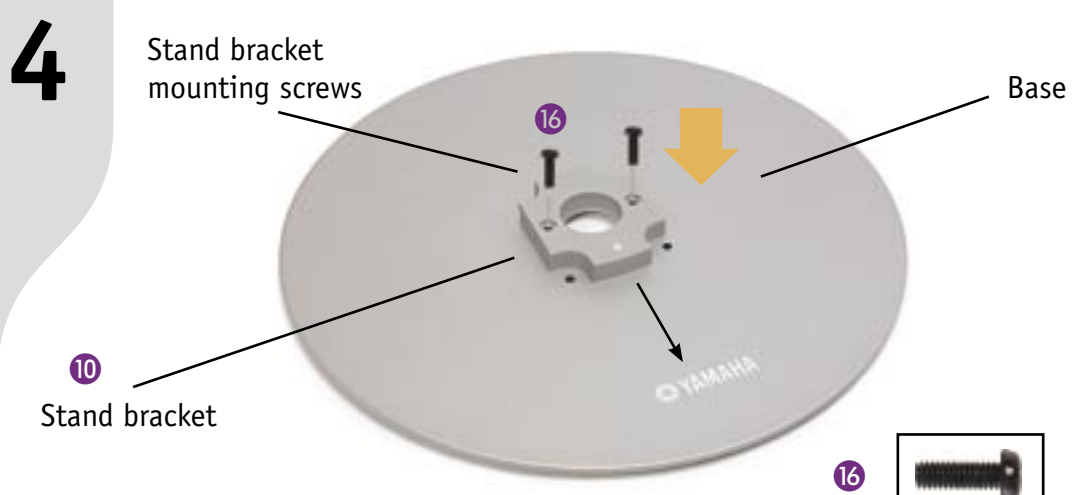

## Speaker Stand Assembly

**Connect Stand Bracket to Base** Align the arrow on the stand bracket to Yamaha logo on base. Use Stand bracket mounting screws (2) to the base. Repeat steps for each bracket and base assembly.



**Attach non-skid pads** to the bottom of the base as shown. Repeat steps for each base.

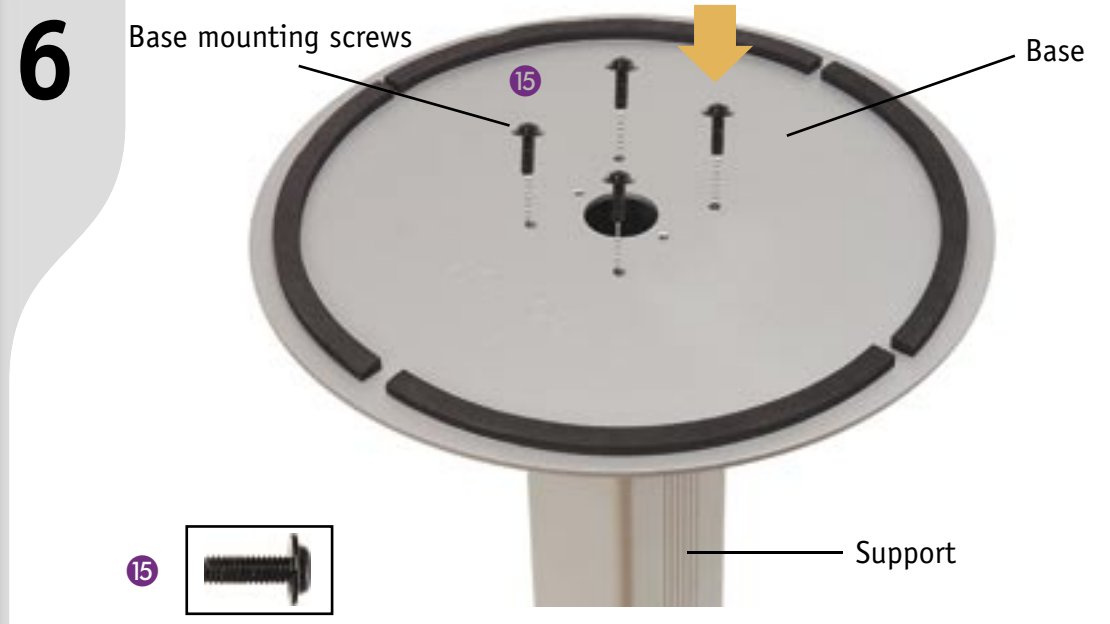

**Attach Support to Base** Use base mounting screws (4) to attach the support to the base as shown. Do not over-tighten the screws. Doing so may damage the screws or assembly. Repeat steps for each base.

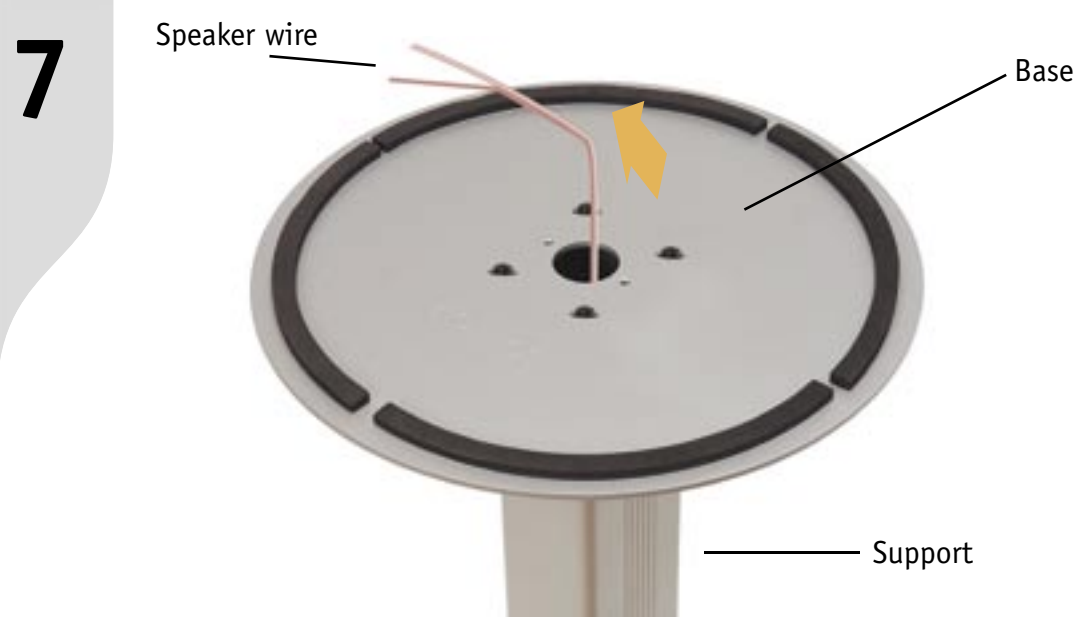

**Cut and Strip Speaker Wire** to appropriate lengths. For both the short supports (2) and tall supports (2) pass the speaker wire through the supports from under the side of the base. Repeat steps for each support and base.

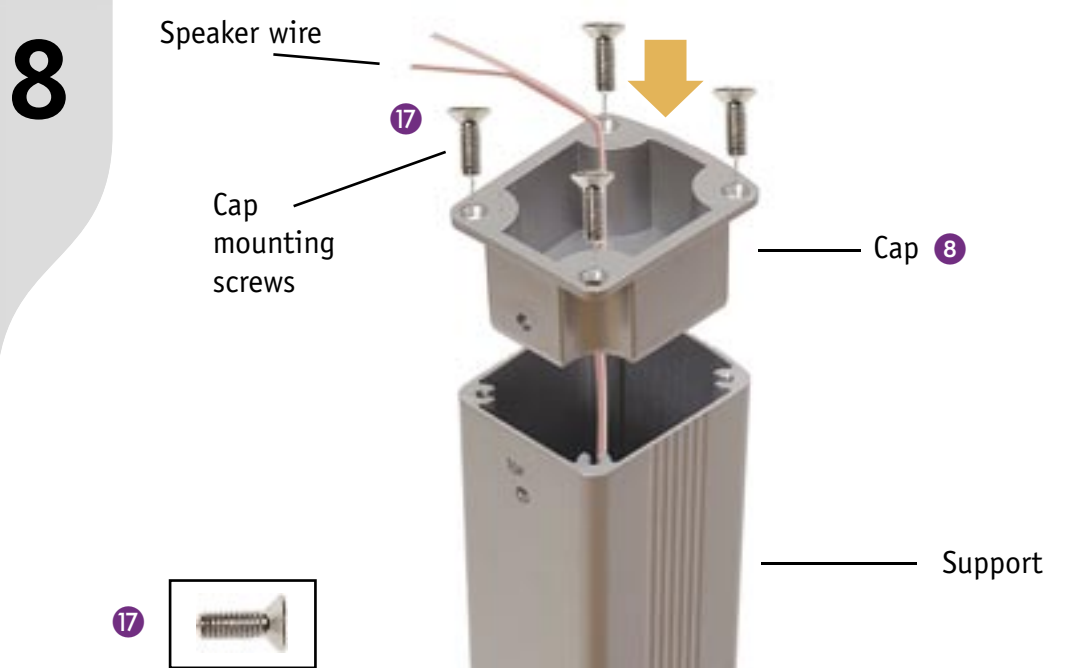

**Pass the Speaker Wire** through the holes in the under side of the cap. Attach the cap to the support with the cap mounting screws (4).

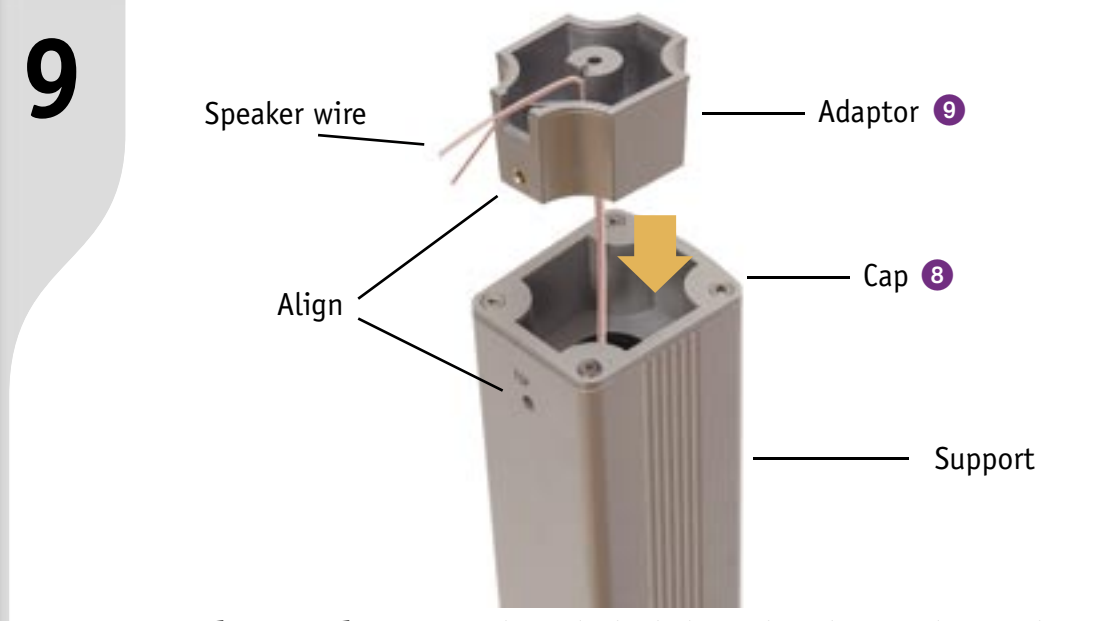

**Pass the Speaker Wire** through the hole in the adaptor. Then push the speaker wire firmly into the groove and pull as shown. Be sure to align screw holes of the adaptor and support as shown. Repeat steps for each support.

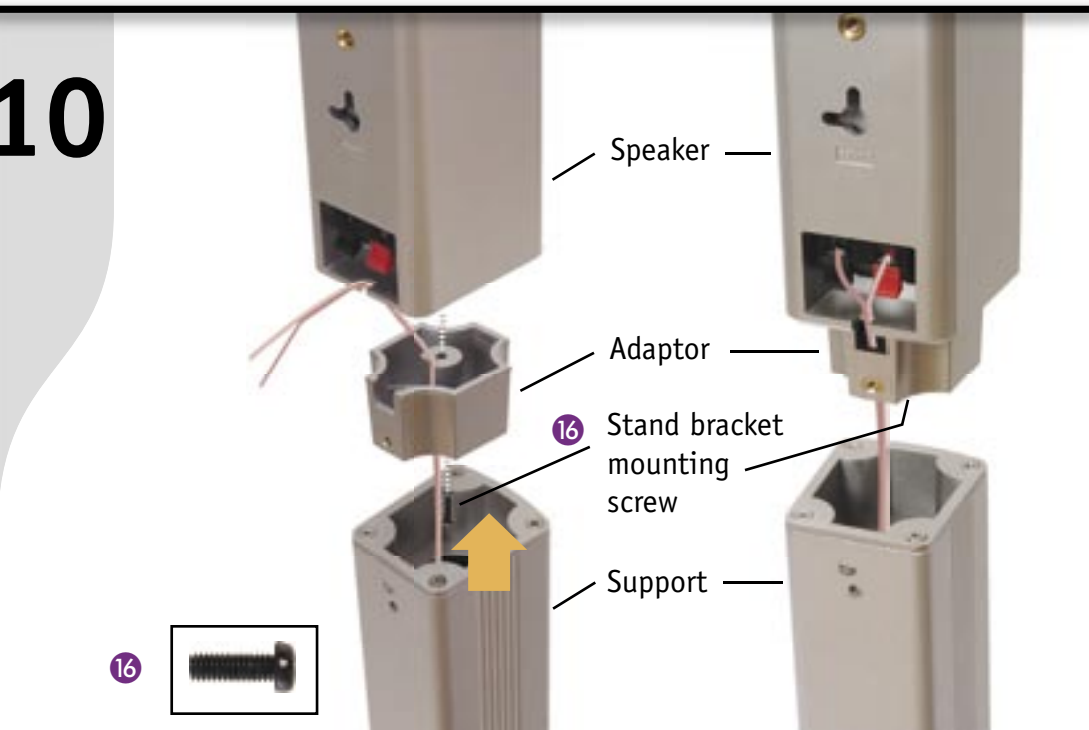

**Pass the Speaker Wire** through the groove in the speaker. Attach the adaptor to the speaker bottom (for front speakers use short support stands and for surround speakers use tall support stands) with adaptor mounting screw. Connect the speaker wire to the speaker terminals. Positive (+) side of the wire with white stripe attaches to (+) terminal. Negative (-) side attaches to (-) terminal. Repeat steps for each speaker.

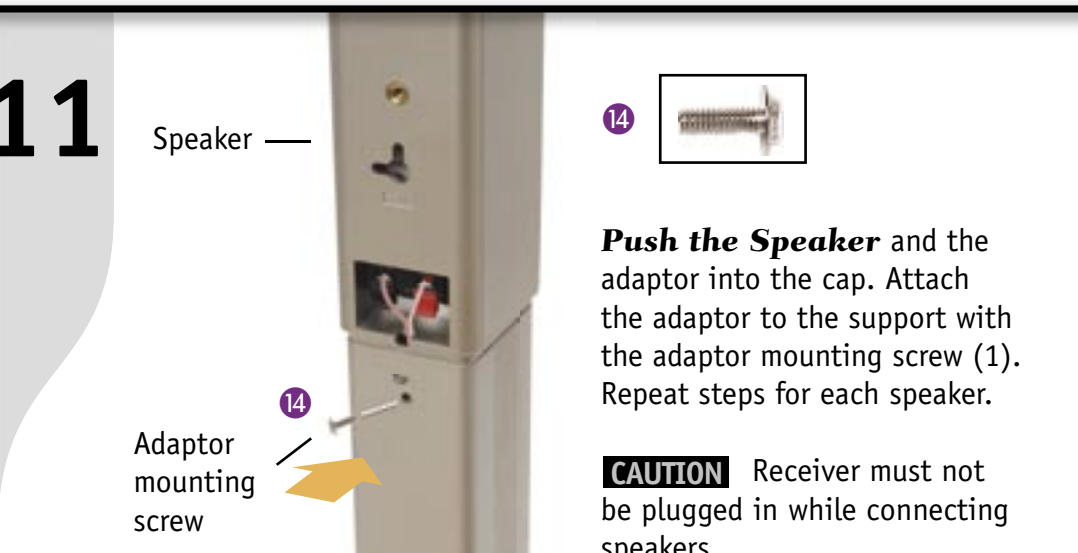

**Push the Speaker** and the adaptor into the cap. Attach the adaptor to the support with the adaptor mounting screw (1). Repeat steps for each speaker.

**CAUTION** Receiver must not be plugged in while connecting speakers.

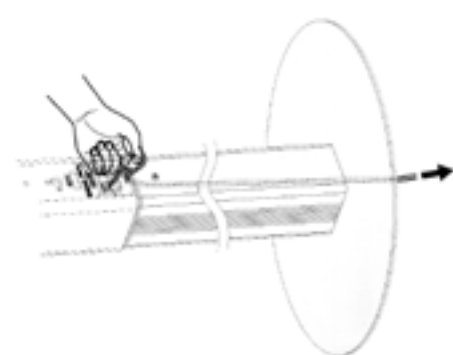

**Carefully Place the Speaker Stand on its Side** Pull the speaker cable gently from the speaker base to remove any slack. Grasp the speaker cables with one hand close to the speaker terminals to prevent any damage to the terminals while doing this. Repeat steps for each speaker.



## Speaker Connections

**Connect Front Speakers and Surround Speakers** Positive (+) side of the wire with white stripe attaches to (+) terminal. Negative (-) side attaches to (-) terminal.

**CAUTION** Receiver must not be plugged in while connecting speakers.



13



HTR-5850 Receiver

**Connect Center Speaker** Positive (+) side of the wire with white stripe attaches to (+) terminal. Negative (-) side attaches to (-) terminal.

**CAUTION** Receiver must not be plugged in while connecting speakers.

14



NX-SW200 Subwoofer

HTR-5850 Receiver

### Subwoofer Connection

**Connect RCA Cable** Connect RCA cable ⑧ to subwoofer ④. Connect RCA cable to receiver from subwoofer.

**WARNING** Receiver must not be plugged in while connecting subwoofer.

15

### Antenna Connection

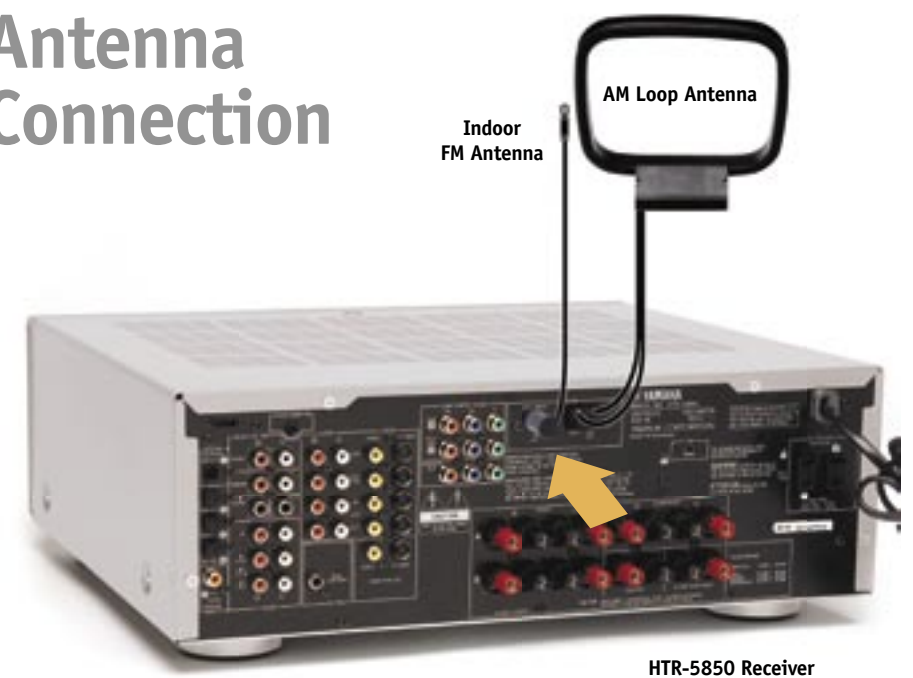

HTR-5850 Receiver

**Connect Antennas to Receiver** Locate AM loop antenna and indoor FM antenna. Keeping receiver unplugged, connect as shown. For more information about obtaining clear reception and grounding, see your Owner's Manual.

16



HTR-5850 Receiver

DVD Player

### DVD Player Connection

**Connect DVD Player (optional)** Connect cable from video out of DVD player to DVD video in on receiver as shown.

**WARNING** Components must not be plugged in while connecting them. Wait until all connections are made before plugging in your components.

17

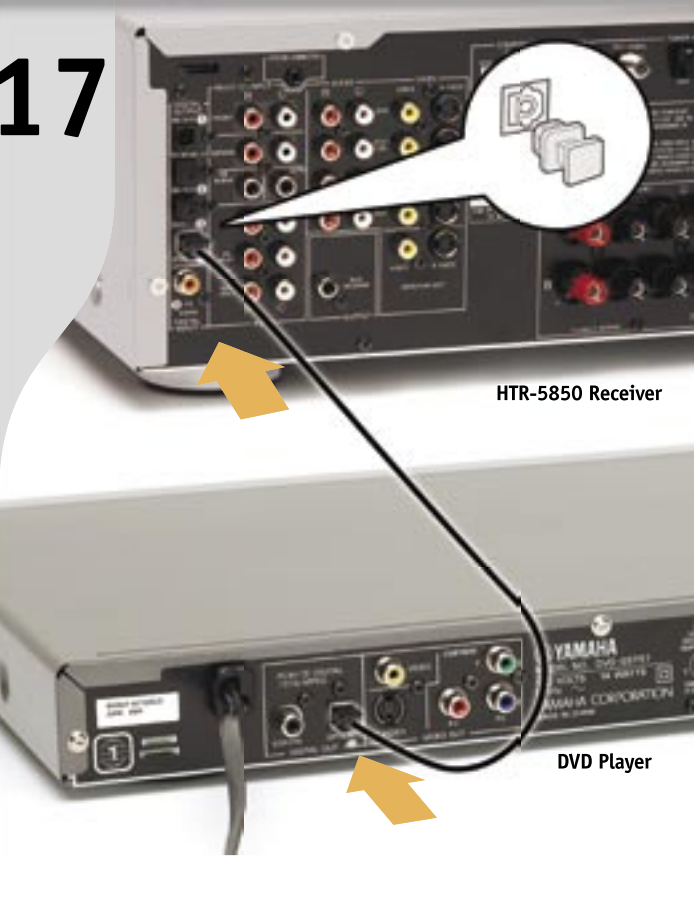

HTR-5850 Receiver

DVD Player

### DVD Player Optical Connection (optional)

Remove dust cap on optical input as shown on inset. Connect optical cable (not included) to receiver. Connect optical cable to DVD player from receiver.

18



HTR-5850 Receiver

VCR

### VCR Connection

**Connect VCR (optional)** Connect audio/video cables (not included) as shown.

**NOTE** VCR shown is for illustration purposes only. When using a hi-fi-stereo VCR, set the Tuner/Line switch on the VCR to "Line" position to record from another source connected to the HTR-5850 receiver.

19



HTR-5850 Receiver

Video Game Console

Audio/Video OUT

### Video Game Console Connection

**Connect Game Console or Video Camera (optional)** Connect RCA audio/video cables (not included) as shown.

20

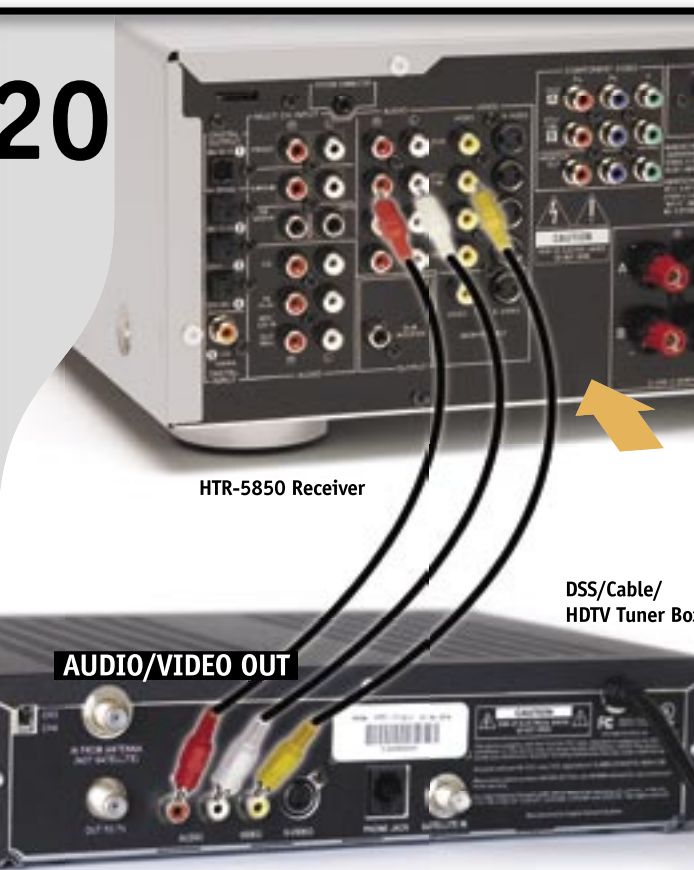

HTR-5850 Receiver

DSS/Cable/HDTV Tuner Box

AUDIO/VIDEO OUT

### DSS/Cable/HDTV Tuner Connection

**Connect DSS/Cable/HDTV Tuner Box (optional)** Connect RCA audio/video cables (not included) and optional optical cable (not pictured) to "DTV/CBL" terminals on receiver to A/V OUT connections on Box as shown.

21

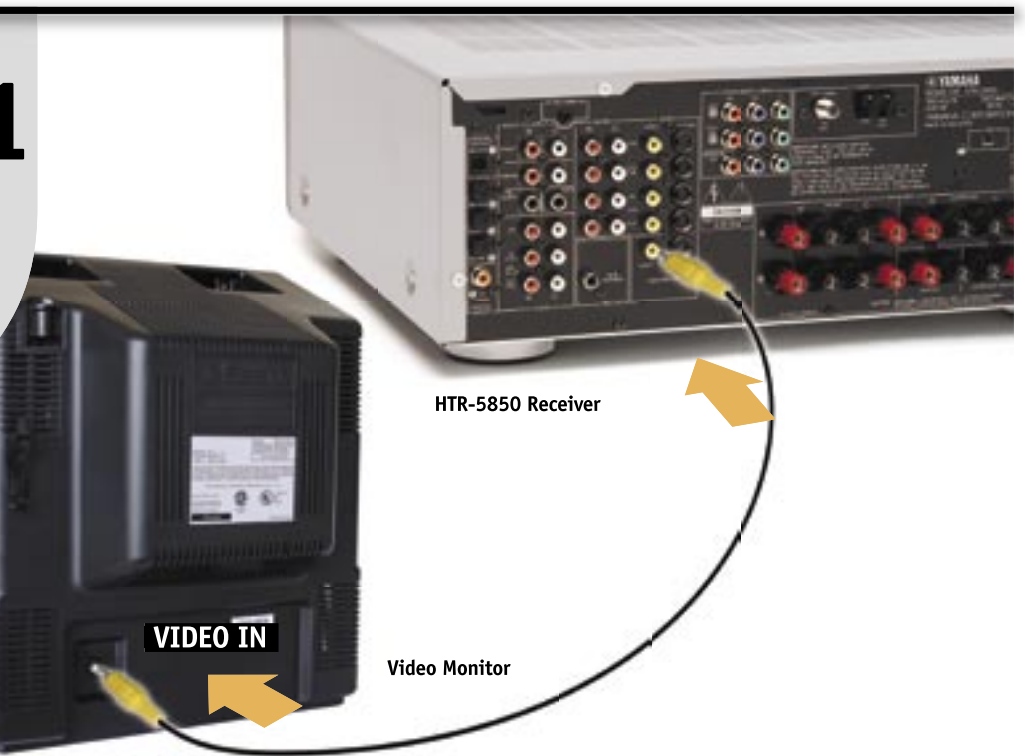

HTR-5850 Receiver

Video Monitor

### Video Monitor Connection

**Connect a Video Monitor (optional)** Connect an RCA video cable (not included) to receiver Monitor OUT from your video monitor as shown.

22



HTR-5850 Receiver

CD Player

### CD Player Connection

**Connect CD Player (optional)** Connect RCA audio cables (not included) to "CD" terminals on receiver as shown. If your CD Player has digital output terminal, connect digital cable (not included) to HTR-5850 Receiver Digital Input terminal. See your HTR-5850 Owner's Manual for more information.

23

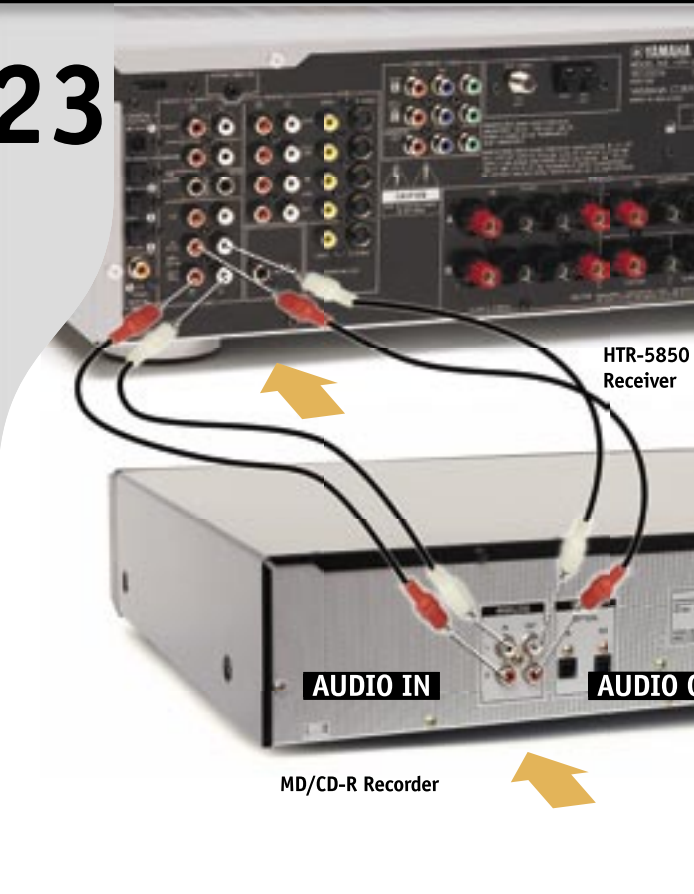

HTR-5850 Receiver

MD/CD-R Recorder

AUDIO IN AUDIO OUT

### MD/CD-R Player Connection

**Connect MD/CD-R Recorder (optional)** Connect RCA audio cables (not included) to "MD/CD-R" terminals on receiver as shown.

24



**Plug In** receiver, subwoofer and other components. Power on the receiver first, and the other components next. Adjust volume on the receiver. Please see each of your respective Owner's Manuals for recommended guidelines and settings.



YAMAHA ELECTRONICS CORPORATION, USA  
6660 Orangethorpe Avenue  
Buena Park, CA 90620  
<http://www.yamaha.com>  
Phone: 1-800-292-2982

©2005 Yamaha Electronics Corporation  
Printed in USA

**Enjoy the Yamaha Home Theater Experience**  
Be sure to put batteries in your remotes (see Owner's Manuals for instructions). Refer to your Owner's Manuals for each component in your system for more information. Now, relax and enjoy the unparalleled sound of your Yamaha Home Theater system.